

Article number: 03008035

Description: Fluro Rod End GARS 35
Housing stainless steel

Measures

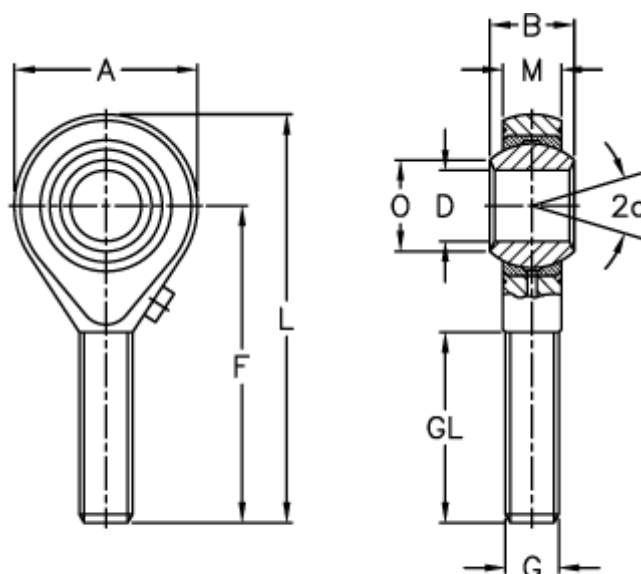

Str. 3-5 uden smørenippel

A	= 80	L	= 165
a (degrees)	= 19	M	= 28
B	= 43	O	= 37.7
D	= 35	Permissible rpm	= 330
Dynamic load C (kN)	= 80	Static load C0 (kN)	= 191
F	= 125	Weight (g)	= 1600
g	= M36x2		
GL	= 77		